

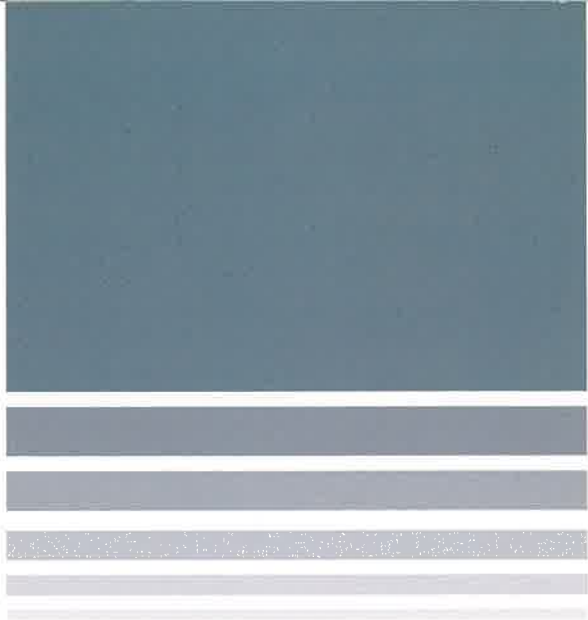

Marine
Machine
Motor Car



Electronics
Energy
Ecology



Pillar Products for **CHEMICAL PLANT**



Since 1924, Nippon Pillar Packing Co., Ltd has contributed to the growth of industries with our total sealing technology. In our long and glorious history, we have always put emphasis on Research and Development, and served the state-of-the-art products in the field of leak preventive products such as mechanical seals, gland packings, gaskets and Pilaflon® products.

PILLAR mechanical seals, by using the superior sealing materials based on our advanced technology and abundant experience, have been employed in much severe applications such as for nuclear power stations. PILLAR packings/gaskets are available with our differential raw material to the requirements of fugitive emission control and of low torque in the valves. Pilaflon® products has used the best suitable material in our integral manufacturing process from raw material.

"Quality first" is our company motto, and we are the first seal manufacturer in Japan to be certified ISO 9001. Also, we were certified ISO 14001 for environmental concern.

In chemical industries, machinery and equipment are various for example, pumps, mixers, kneaders and agitators. That is why the required characteristics are diversified and it is vital to select the suitable sealing products.

This catalogue was prepared to help you select the best suitable products to your specifications in chemical industries. It shows only typical products to cover the specifications as much as possible to minimize the inventory stock. But, our products are not shown exhaustively here. We have PILLAR distributors worldwide to serve you, so please contact us for any further information.



BRAIDING OF GLAND PACKING



LAPPING OF MECHANICAL SEAL



DRY GAS SEAL TEST BENCH



ELECTRON MICROSCOPE



SANDA FACTORY

Selection of seal and packing for pump

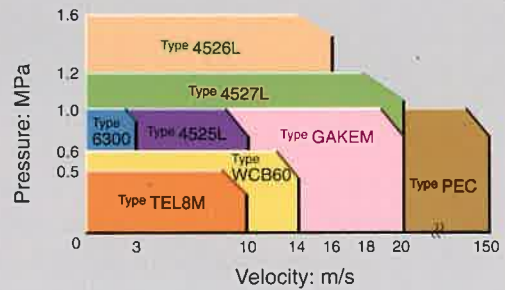

Mechanical Seals

Type TEL8M

SiC χ Seal®



Code: MS-TEL8M-TTJ61 - (Size)

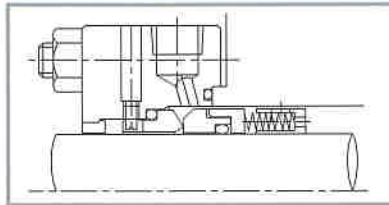

Features & Benefits

For fluid containing particles

This seal is multi spring type seal with solid SiC seal ring and radial grooves on the drive collar. SUS316 is used for metal parts which is applicable to acid, alkaline and wide range liquid.

Performance

Pressure: 0.5MPa (SiC vs SiC), 0.8MPa (SiC vs Carbon)
Velocity: 10m/s, Size: ϕ 20-55, Application: Slurry pump

Type WCB60

Chemi-Mighty Seal

Features & Benefits

Contact seal for mixer

This is outside mounted mechanical seal which uses PTFE bellows and SiC as mating ring. So this type has excellent chemical resistance, Chemi-mighty seal can be mounted on ceramic or glass lining sleeve.

Performance

Pressure: 0.6MPa, Velocity: 14m/s, Size: ϕ 20-100
Application: Chemical solution, High viscosity liquid, Slurry



Code: MS-WCB60-TF022 - (Size), SiC vs SiC & PTFE, 316 SS

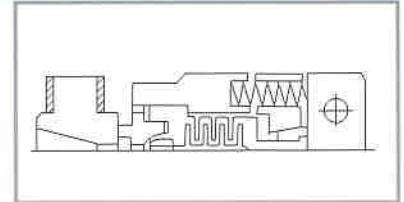

Type GAKEM

Cassette Seal® (Knife Edge)



Code: MS-GAKEM-TF022 - (Size), SiC vs SiC & Fluoro Elastomer, 316 SS

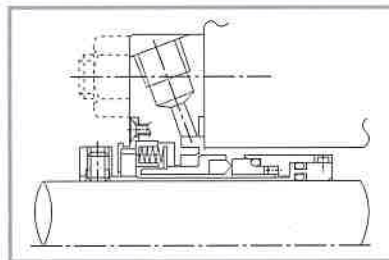

Features & Benefits

Easy installation

This is cassette type seal providing easy installation. Replacement from gland packing is not required any modification.

Since this seal uses knife edge mating ring, it provides the stable performance against high viscous or slurry liquid.

Performance

Pressure: 1.0MPa, Temperature: -20-150°C, Size: ϕ 20-100
Application: High viscous liquid, Polymeric liquid

Type PEC®*

Hydrostatic dry gas seal

Features & Benefits

Suitable for environmental regulation, pharmaceutical and biochemical industries

The barrier gas is supplied into the grooves on the seal face from outside through the orifices and the opening force lifts off the seal faces to non-contact state. The seal gas consumption from narrow gap is small and process gas is sealed hermetically.

(Patent Pending US, EP, KR, CN, TW, BR, UR)

Performance

Pressure: 1.0MPa, Velocity: 150m/s, Size: ϕ 25-400
Application: Turbine, Blower, Compressor, Mixer, Fan

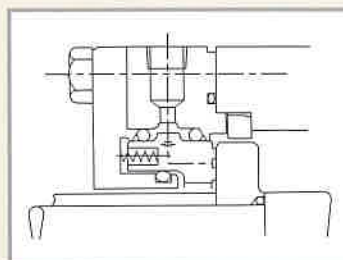

Code: MS-PEC - *** - (Size), Carbon vs SiC (Ceramic coated SUS) & Fluoro Elastomer, 316 SS

Selection of valve packing

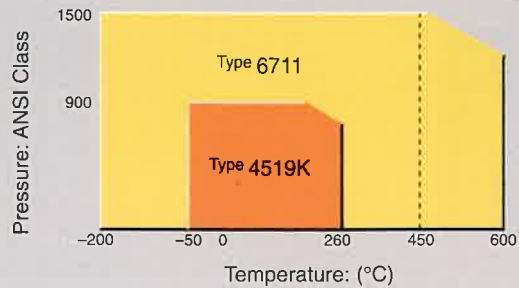

Gland Packings

Type 4525L

Pilaflon® fiber packing

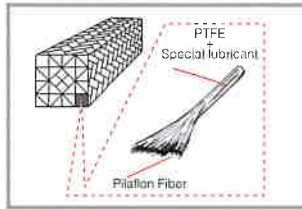

Features & Benefits

For chemicals

This is an interlocked, braided packing, consists of the PTFE fiber impregnated with a special lubricant and PTFE resin liquid. This packing is extremely flexible and makes uniform contact with shaft, ensuring a stable sealing effect for a long time.

Performance

Temperature: 120°C, Pressure: 1.0MPa, Velocity: 10m/s, PV value: 4.9MPa-m/s
Application: Pump, Mixer

*Cooling is required for liquid over 80°C

Code: GP-4525L - (Size)

Type 4526L

Aramid fiber packing



Features & Benefits

Aramid fiber packing

This is a packing consisting of the aramid fiber impregnated with PTFE dispersion and heat resistant lubricant. It is interlocking braided packing and creates a stable sealing ability and stability for a long time.

Performance

Temperature: 260°C, Pressure: 1.6MPa, Velocity: 16m/s, PV value: 14.7MPa-m/s
Application: Slurry liquid, Boiler feed pump

*Cooling is required for liquid over 80°C

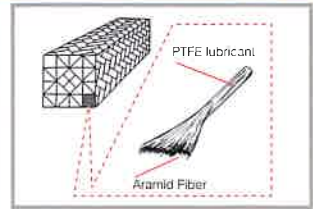

Code: GP-4526L - (Size)

Type 4527L

Special Pilaflon® fiber packing

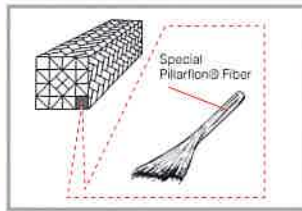

Features & Benefits

Special Pilaflon super packing for chemical

This is an interlocked, braided packing, consists of the PTFE fiber and containing highly pure graphite and special lubricant. The original interlocked braiding system enables uniform contact with shaft and creates a stable sealing effect for a long time.

Performance

Temperature: 260°C, Pressure: 1.2MPa, Velocity: 20m/s, PV value: 12.3MPa-m/s
Application: Slurry liquid

*Cooling is required for liquid over 80°C

Code: GP-4527L - (Size)

Type 4519K

Pillar emission defense Pilaflon® packing



Features & Benefits

Flexible graphite used as core material, which is covered with the braided PTFE fiber.

Performance

Temperature: -50~260°C, Pressure: ANSI Class 900
Application: Valve, Control valves

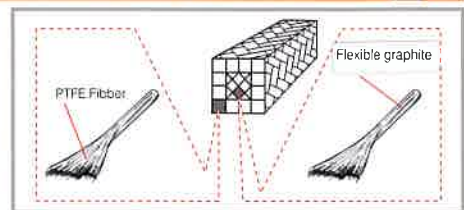

Code: GP-4519K - (Size)

Type 6711

Pillarfoil® Braided Packing (Mark III®)

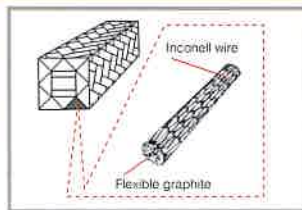

Features & Benefits

For high temperature & pressure valve

This is Pillarfoil® packing braid over braid, reinforced by inconel wire. It's recommended in high temperature and high pressure.
(JS 4705722 EP 253031 KR 42430)

Performance

Temperature: -200~600°C (450°C for oxidizing atmosphere)
Pressure: ANSI Class 1500

Application: High pressure and high temperature valve, Manhole

Code: GP-6700 - (Size)

Selection of gasket

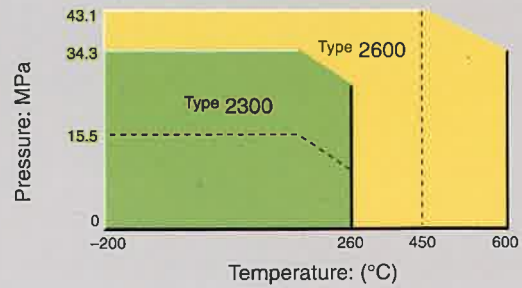

Type 6300*

Live seal unit®

Features & Benefits

For low velocity equipment

This is the new packing system consists of the gland packing, spring and collar. The live loading system (spring pressing force) enables no stress relaxation for a long period of time, reduces leakage amount and maintenance cost.

(Patent Pending US EP KR TW CN)

Performance

Application: Mixer, Kneader, Dryer

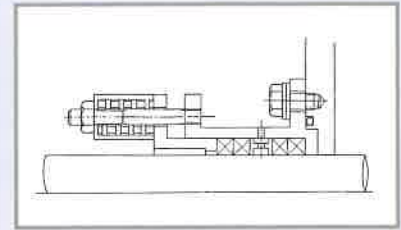
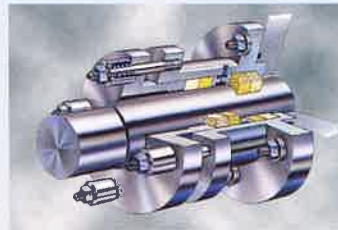

Code: GP-6300 - (Size)

Gaskets

Type 3356-B*

Clean sanitary Gasket

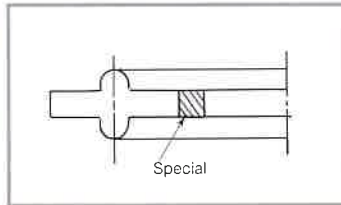

Features & Benefits

Conform to revised GMP

This gasket is made of 100% PTFE materials, excellent in heat resistance as well as chemical resistance property, against acid, alkaline, etc.

(US 5971399, 5749586 EP Pending KR 193032)

Performance

Temperature: 200°C

Application: Joint gasket for sanitary field

Code: VG-3356-B - (Size)

Type 2300

Pillarfoil® spiral wound gasket

Features & Benefits

Spiral wound gasket using Pilaflon® filler

This is using 100% PTFE Pilaflon®, a highly pliable and elastic soft tape. It is superior in gas sealability and chemical resistance. It can be used for any kind of fluid.

Performance

Temperature: -200~260°C, Pressure: 34.3MPa (for liquid), 15.5MPa (for gas)

Application: Flanges for pipe, Equipment

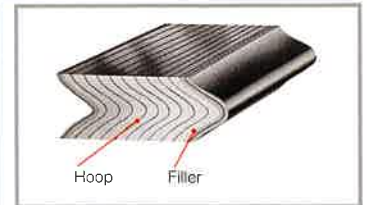

Code: Standard
With inner ring
With inner/outer ring

VG-2300-EEO-ANSI (Size) LB-00"
VG-2301-EEO-ANSI (Size) LB-00"
VG-2303-EEE-ANSI (Size) LB-00"

Type 2600

Pillarfoil® spiral wound gasket

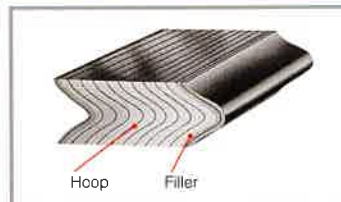

Features & Benefits

Spiral wound gasket using Pillarfoil® filler

It is superior in gas sealability, heat resistance and chemical resistance. It can be used in vacuum, LNG, nuclear application as well as general application.

Performance

Temperature: -200~600°C (450°C for oxidizing atmosphere)

Pressure: 43.1MPa (ANSI Class 2500)

Application: Flanges for pipe, Equipment

Code: Standard
With inner ring
With inner/outer ring

VG-2600-EEO-ANSI (Size) LB-00"
VG-2601-EEO-ANSI (Size) LB-00"
VG-2603-EEE-ANSI (Size) LB-00"

PTFE Products

Type 4368









Code: PF-4368 - (Material) - (Type) - S - (Size) - (Size)

Performance

Temperature: -200~260°C
 Pressure: 25.5MPa (Type 10), 68.6MPa (Type 20)
 Velocity: 1m/s
 PV value: 50MPa-cm/s

HiP Seal

Type:10 	Type:20 	Type: 10,20 Function: Static type, Rotating type Application: Gland seal for low temperature valve, plunger pump and nuclear control rod
Type:11 		
Type:12 	Type:22 	Type: 12, 22 Function: Inner pressure Application: Flange gasket
Type:13 	Type:23 	

Type 4370

Piston ring

Features & Benefits

New material for piston ring

This is a lubricant-free piston ring made of filled Pilaflon®, ensuring a stable sealing effect for a long time.

Performance

Temperature: -100~220°C, Pressure: 9.8MPa, Velocity: 4m/s
 Application: Oil-free compressor, Reciprocating equipment



Code: PF-4370 - (Material) - (ID) × (OD) × (T)

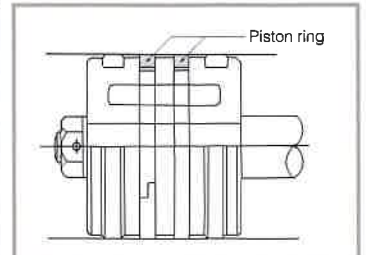

Type 4391~4394

Rod packing



Code: PF-439* - (Type) - (Material) × (ID) × (OD) × (T)

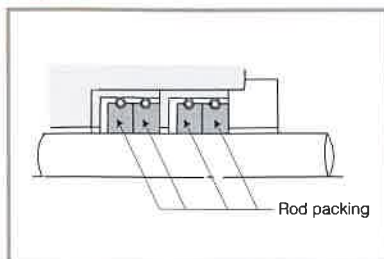

Features & Benefits

New material for rod packing

This is a lubricant-free rod packing made of filled Pilaflon®, ensuring a stable sealing effect for a long time.

Performance

Temperature: -100~220°C, Pressure: 2.9MPa, Velocity: 4m/s
 Application: Oil-free compressor, Reciprocating equipment

Pillar products for chemical plant



PUMP



MIXER



AGITATOR

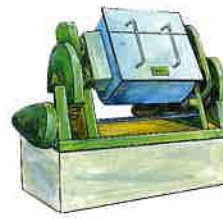

KNEADER



DRYER

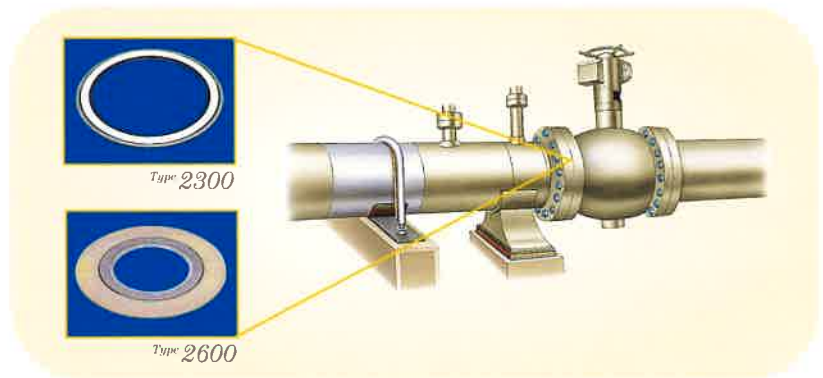



NIPPON PILLAR PACKING CO., LTD.

<http://www.pillar.co.jp/>

E-mail : info@pillar.co.jp

Head Office

11-48, Nonakaminami 2 Chome, Yodogawa-ku, Osaka, 532-0022 Japan.
Tel : 81-(0)6-6305-2821 Fax : 81-(0)6-6302-3300

Tokyo Office

2-2, Uchisaiwaicho 2 Chome, Chiyoda-ku, Tokyo, 100-0011 Japan.
Tel : 81-(0)3-3508-1611 Fax : 81-(0)3-3508-1881

Nippon-Pillar-Corporation-of-America

1562, Parkway Loop, Suite2C, Tustin, CA 92780, USA.
Tel : 1-714-258-7741 Fax : 1-714-258-7760

Nippon-Pillar-Singapore-Pte.,Ltd.

10 Toh Guan Road #09-01 TT International Tradepark, Singapore 608838
Tel : (65)861-7138 Fax : (65)862-9098

*Specifications and dimensions are subject to change without prior notice.
*The data on this catalogue are solely for your reference and are not to be construed as constituting a warranty.



CAUTION

Read through and follow the instructions on the manual before installation and operation for your safety.